

1,5mm Sperrholz

1x

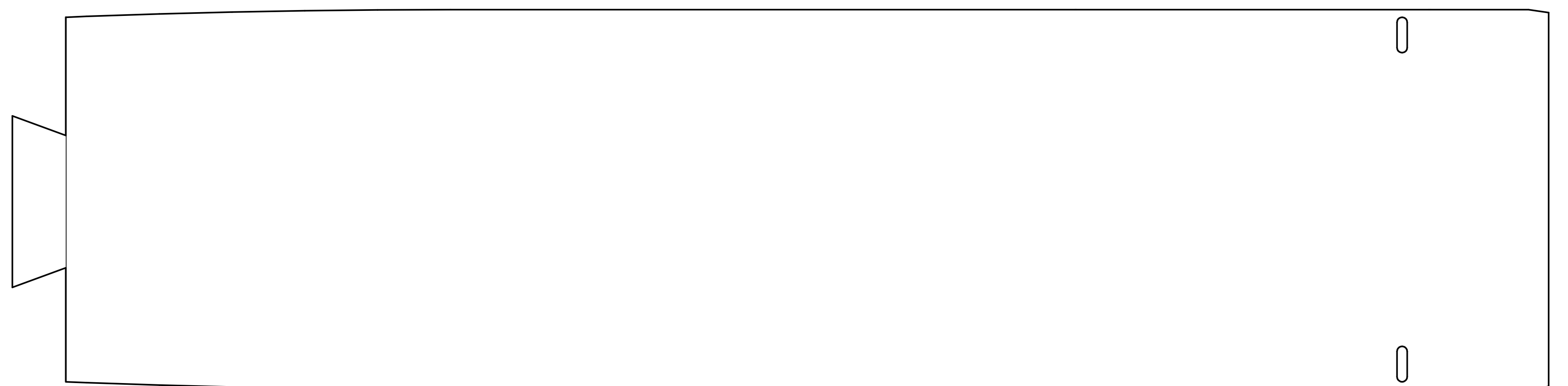
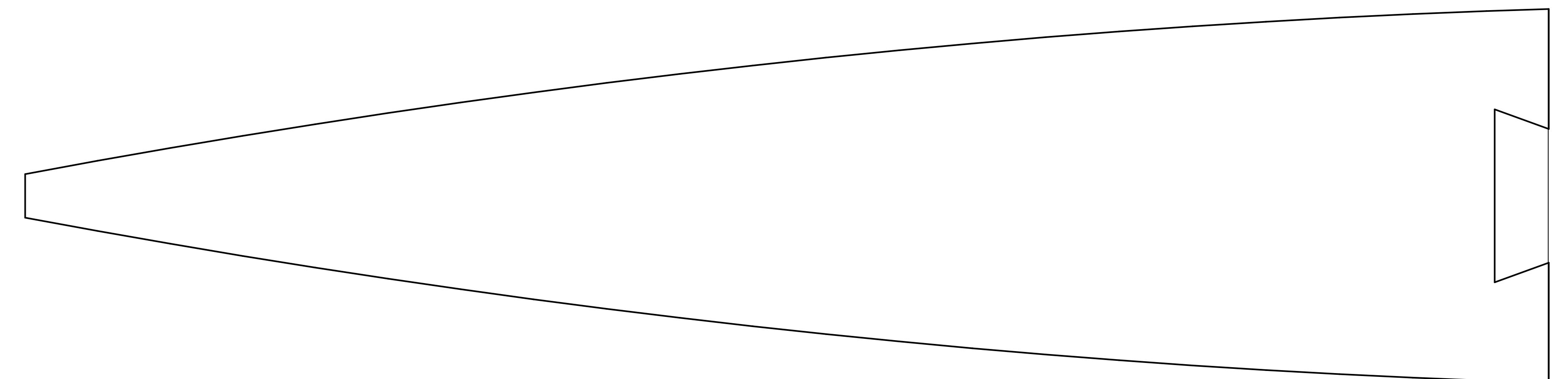
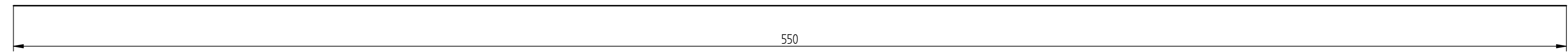
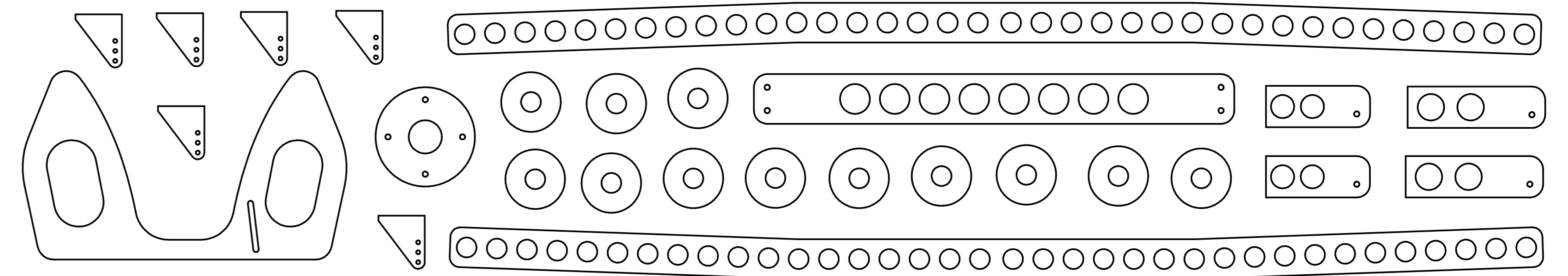

3mm Depron

1x

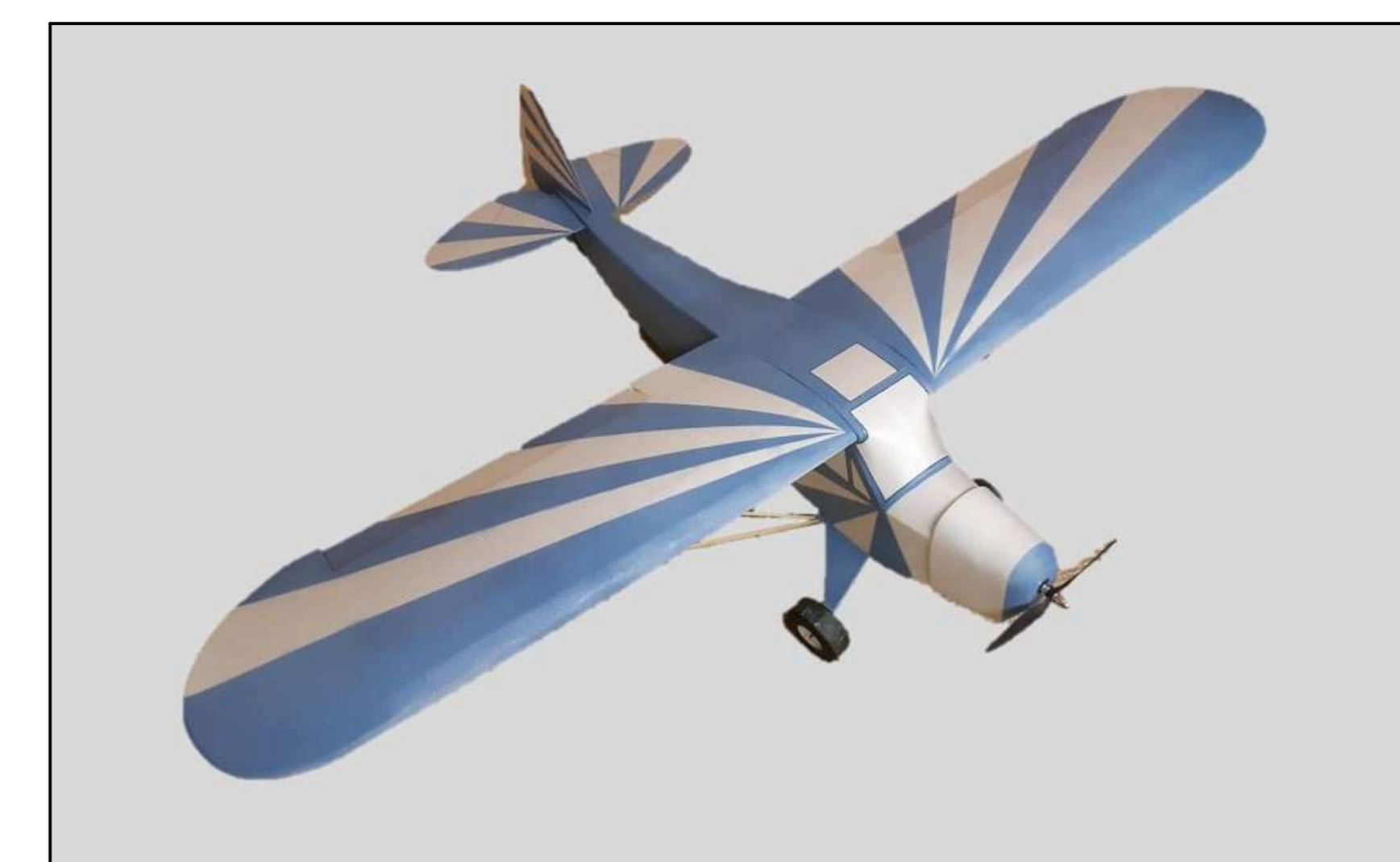
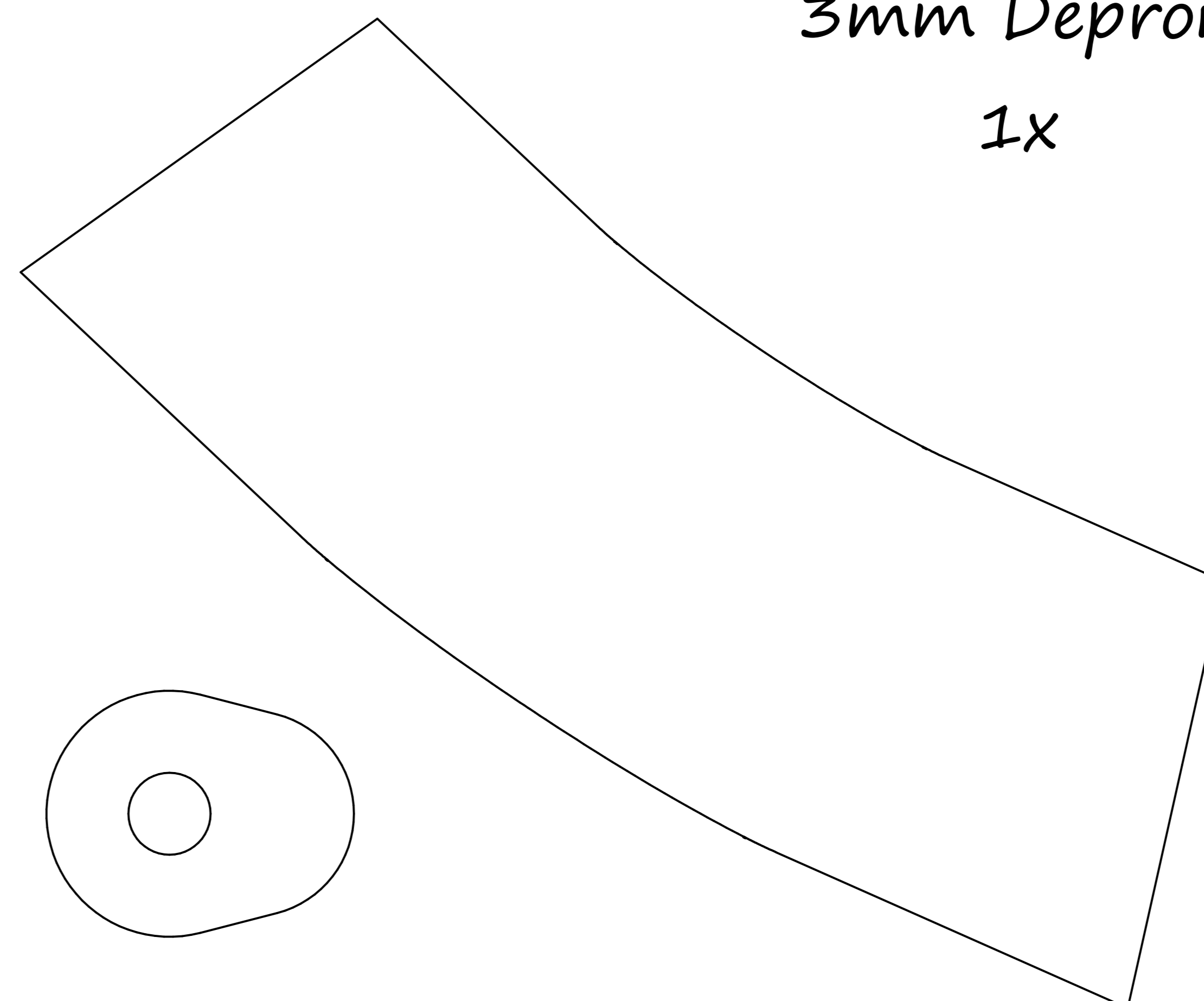

Piper Clipped Wing

Gewicht: ca. 400g

Spannweite: 160cm

RC Funktionen: Motor, Quer, Höhe, Seite

Servos: 3,7g 4x

Akku: 2S 450mA - 3S 450mA

Motor: ca. 300g Schub oder mehr

Konstruktion: Chr. Westarp **DIN A0**

6mm Depron

3mm Depron

2x

2x

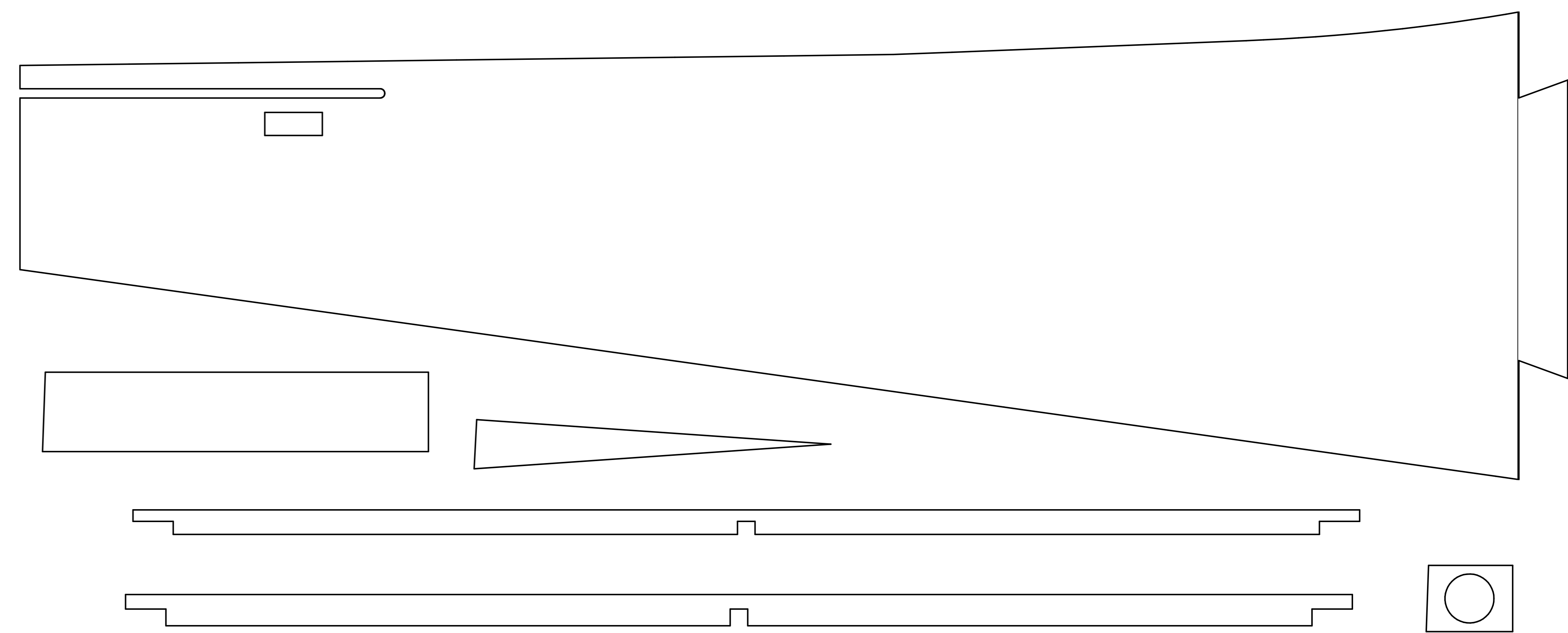
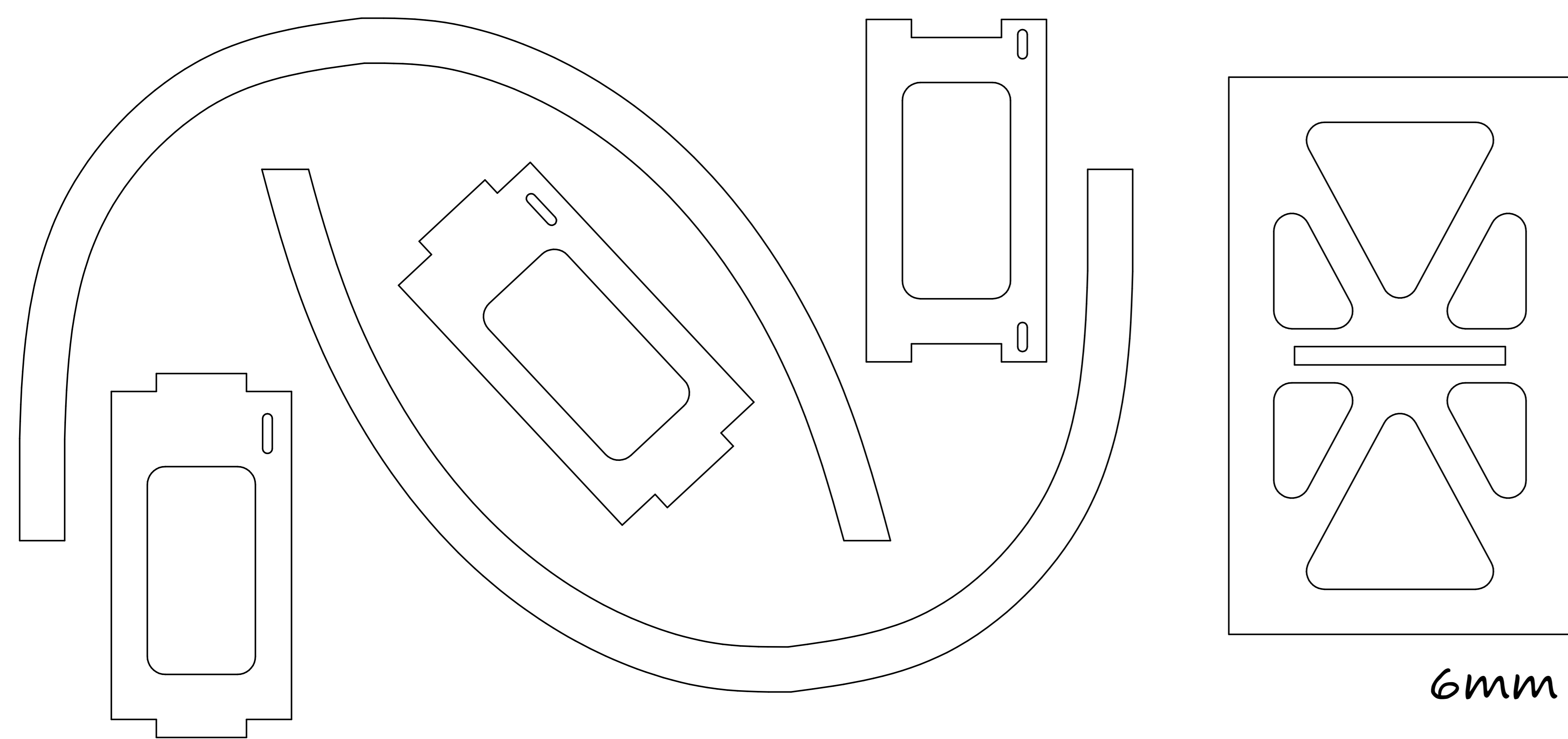
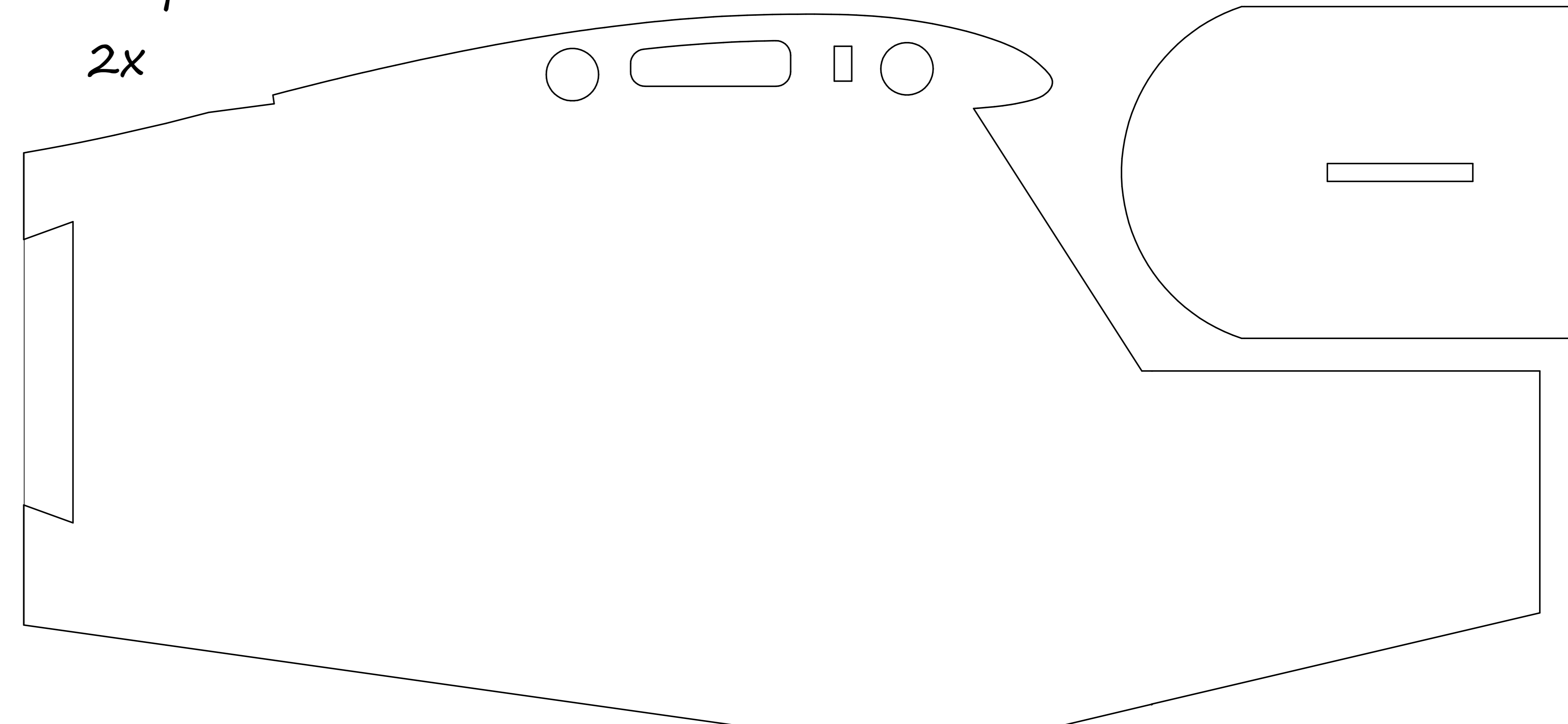
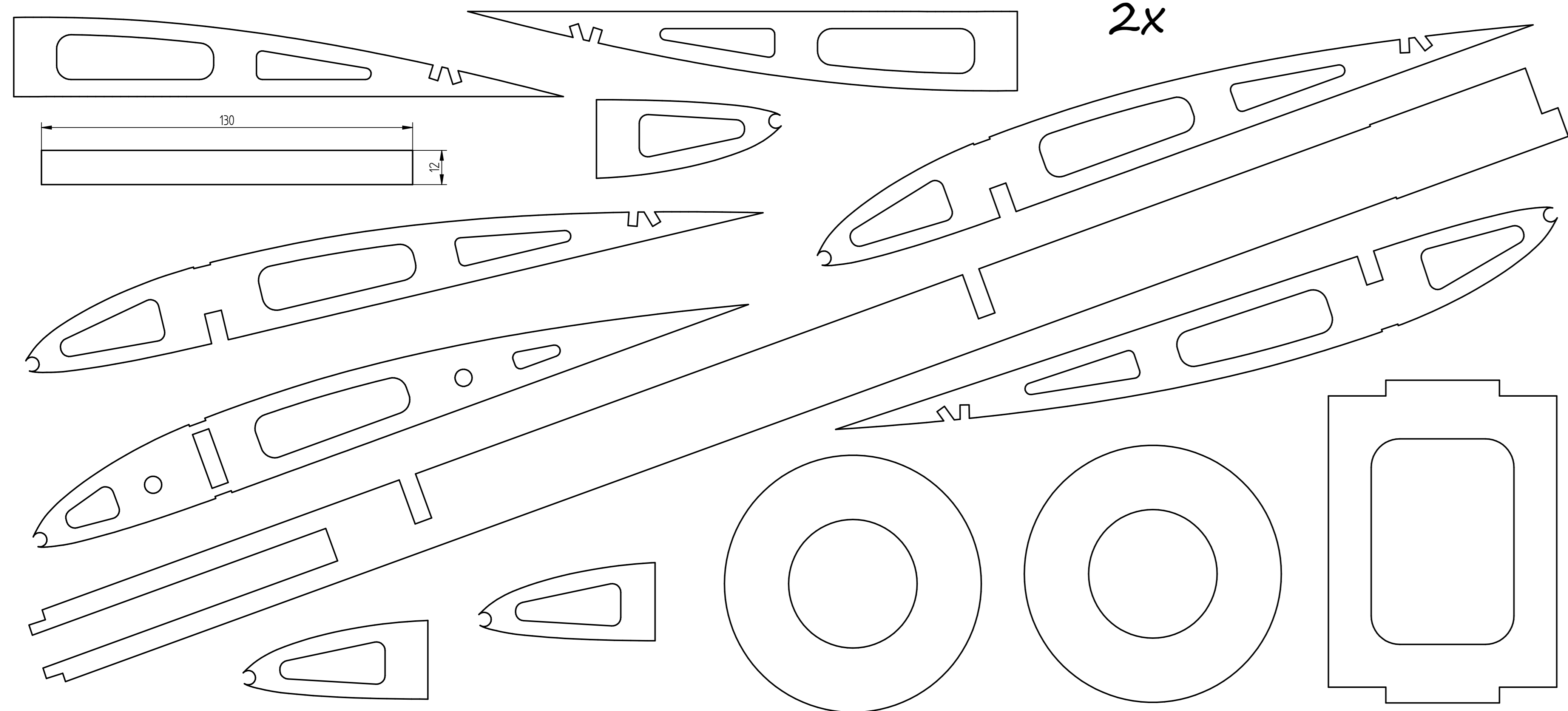

6mm Depron

1x

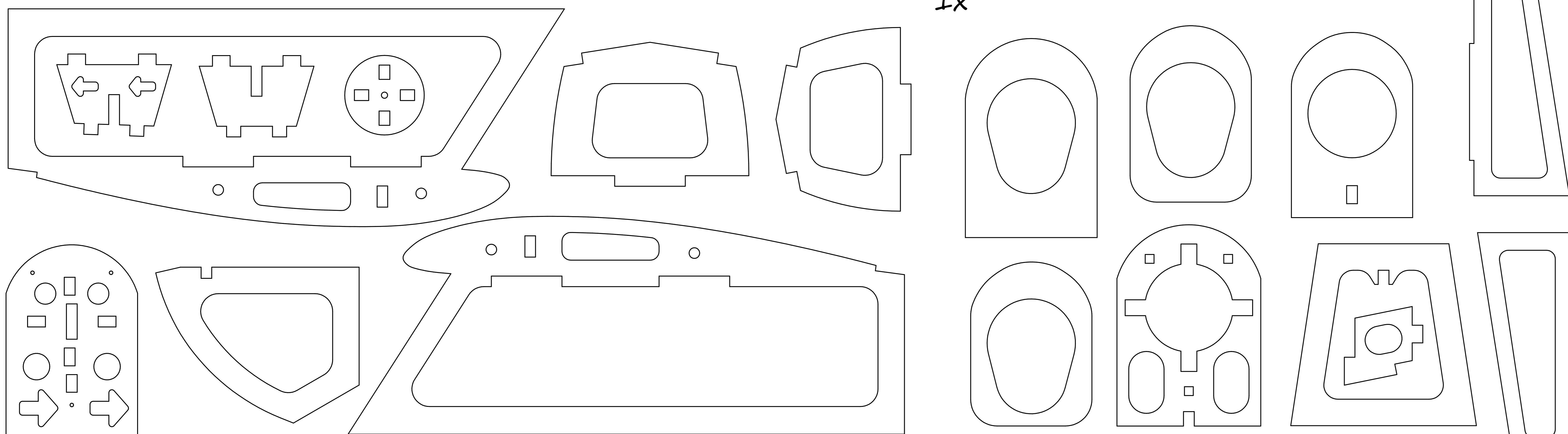

Piper Clipped Wing

Gewicht: ca. 400g
 Spannweite: 160cm
 RC Funktionen: Motor, Quer, Höhe, Seite
 Servos: 3,7g 4x
 Akku: 2S 450mA-3S 450mA
 Motor: ca. 300g Schub oder mehr

Konstruktion: Chr. Westarp

DIN A0

500

6mm Depron

1x

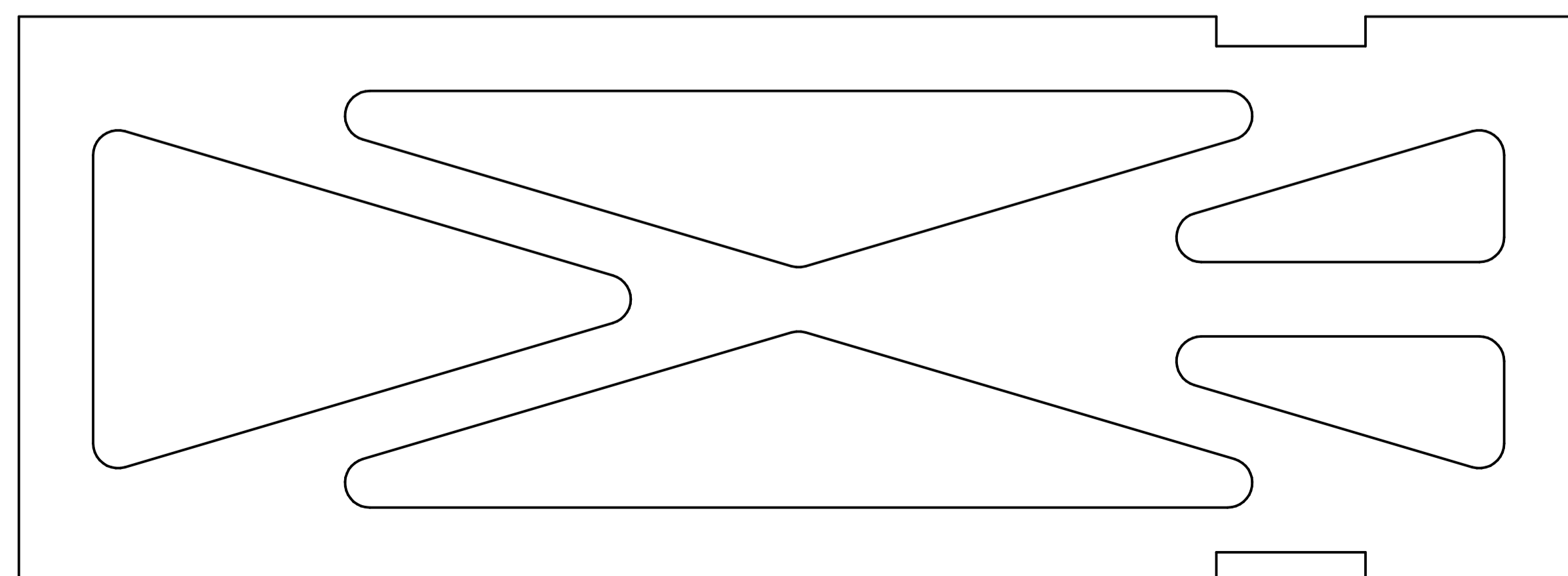
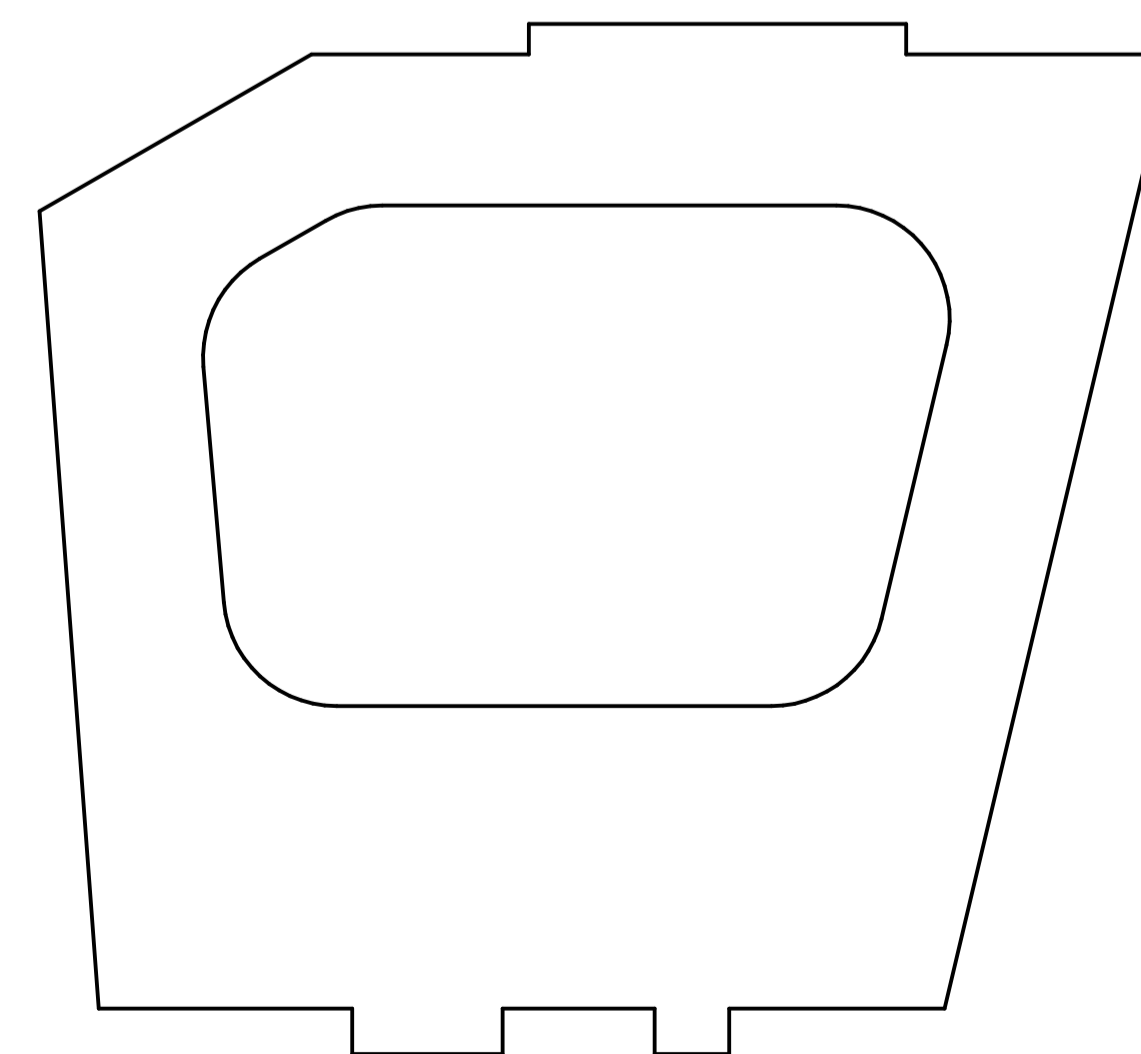
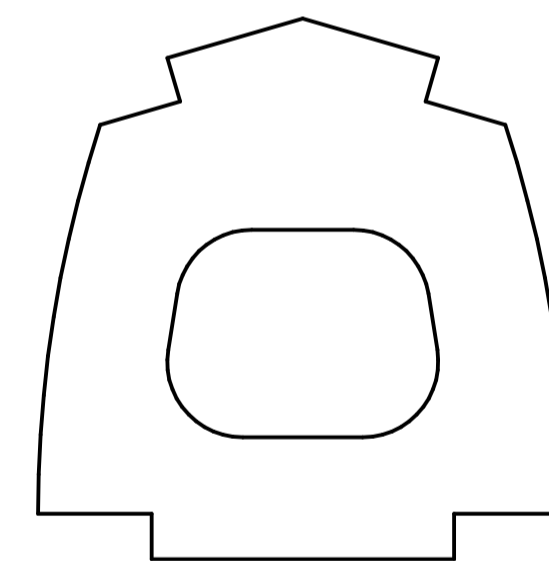
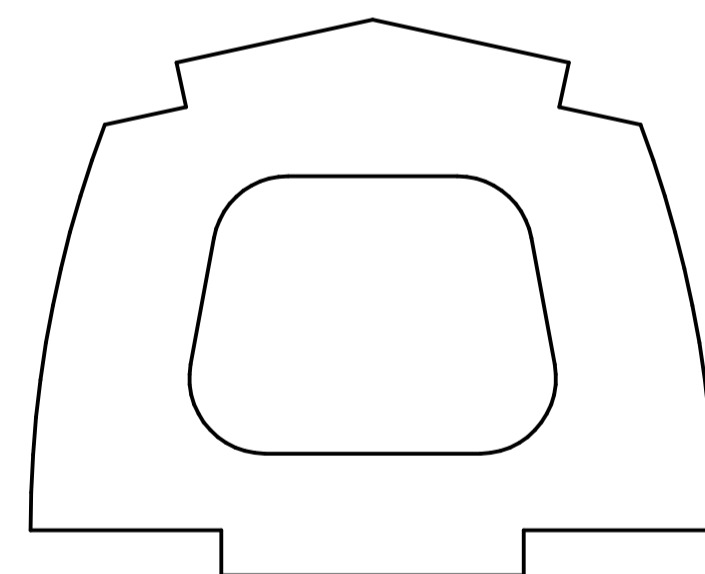
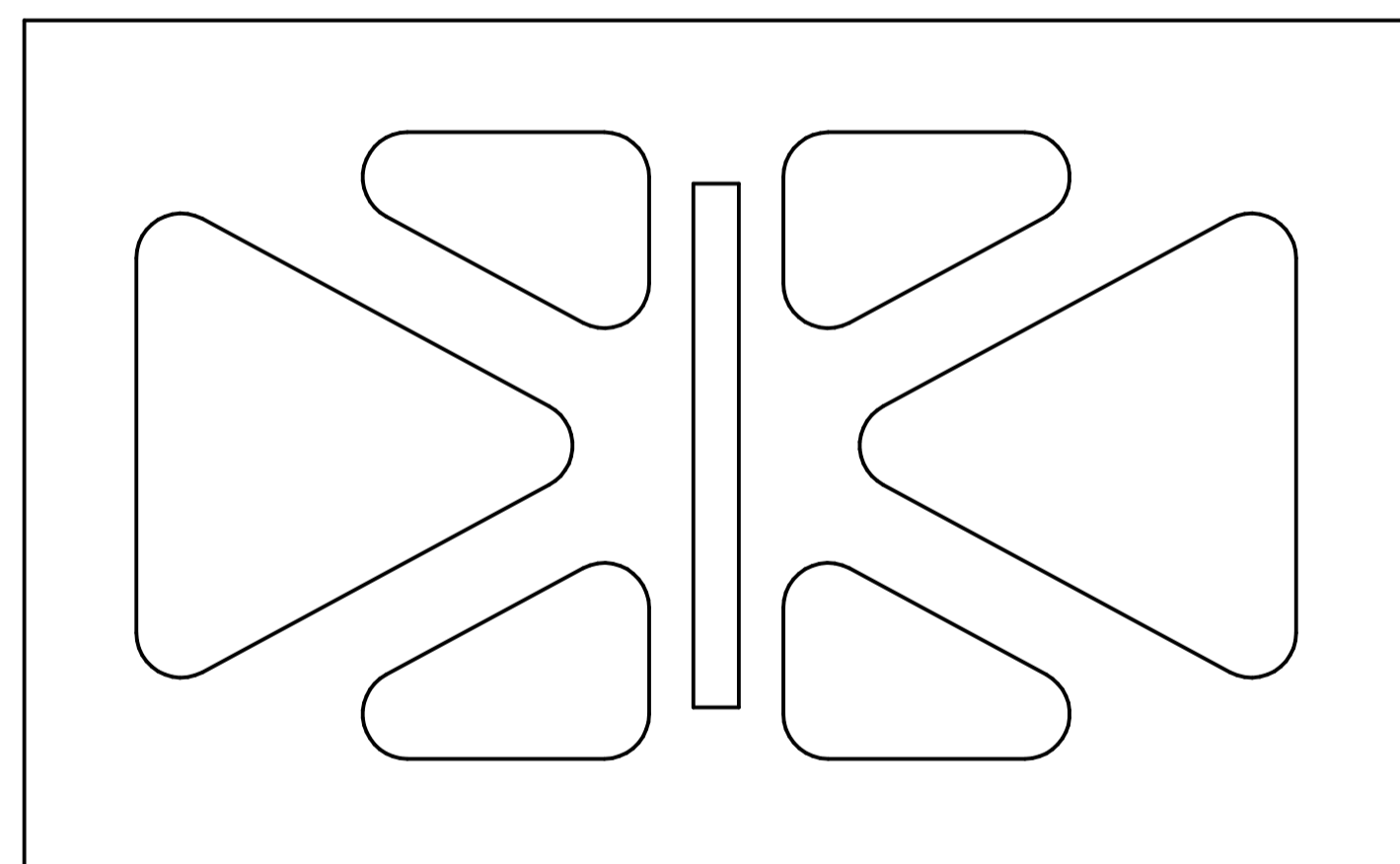
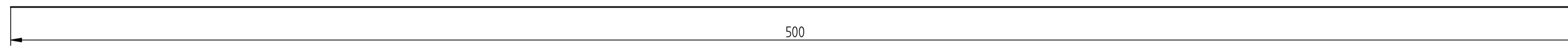
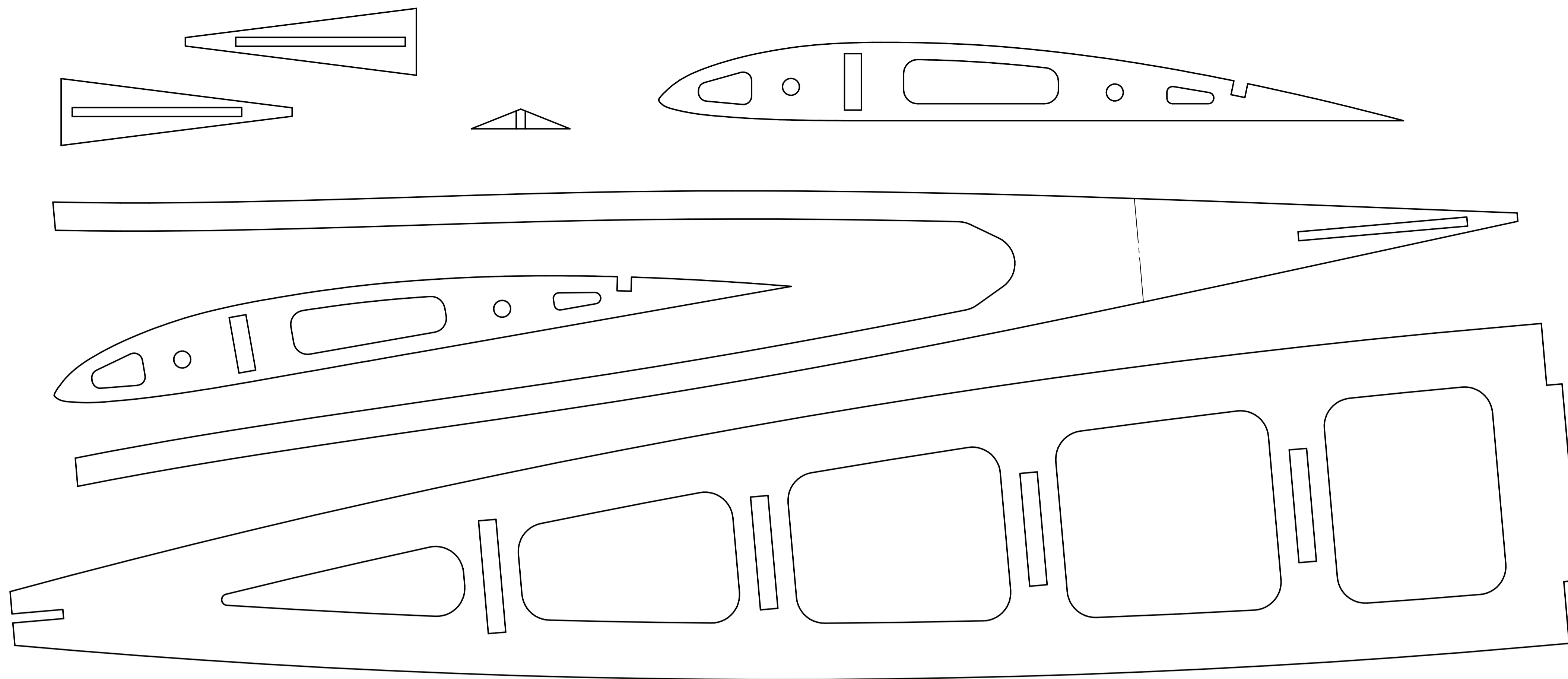

Piper Clipped Wing

Gewicht: ca. 400g

Spannweite: 160cm

RC Funktionen: Motor, Quer, Höhe, Seite

Servos: 3,7g 4x

Akku: 2S 450mA-3S 450mA

Motor: ca. 300g Schub oder mehr

Konstruktion: Chr. Westarp

DIN A1